

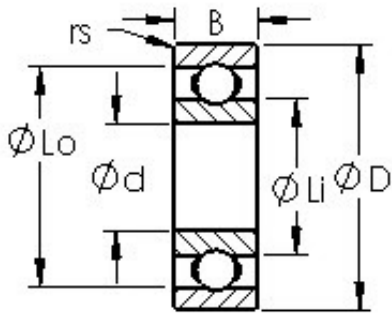

Thk Environmental Axis.



6005 Bearing 2D drawings and 3D CAD models

AST 6005 Cojinetes de bolas profundas

Bearing No. 6005

Size	25x47x12 mm
Bore Diameter	25 mm
Outer Diameter	47 mm
Width	12 mm
Bearing Type	Open
Bore Dia (d)	25.0000
Outer Dia (D)	47.0000
Width (B)	12.0000
Radius (min) (rs)	0.600
Dynamic Load Rating (Cr)	10,100
Static Load Rating (Cor)	5,850
Max Speed (Grease) (X1000 RPM)	15
Max Speed (Oil) (X1000 RPM)	18
Max. Shaft Shoulder Dia. Inner (Li)	31.7
Min. Housing Shoulder Dia., Outer (Lo)	40.2
Ball Qty	10
Ball Dia (Dw)	6.3500
Weight (g)	80.00
Precision	A1
Standard Clearance	C0
Material	52100 Chrome Steel or equivalent