

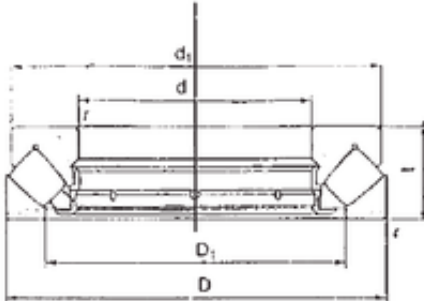

Thk Environmental Axis.

FBJ 29418M Rodamientos Axiales De Rodillos



Bearing No. 29418M

Size	90x190x60 mm
Bore Diameter	90 mm
Outer Diameter	190 mm
Width	60 mm
d	90 mm
D	190 mm
T	60 mm
d1	162 mm
r min.	2,1 mm
D1	127 mm
Weight	8,38 Kg
Basic dynamic load rating (C)	545 kN
Basic static load rating (C0)	1680 kN

29418M Bearing 2D drawings and 3D CAD models